

NCK

NOVA HC65



Hydraulic Crawler Crane

DATA

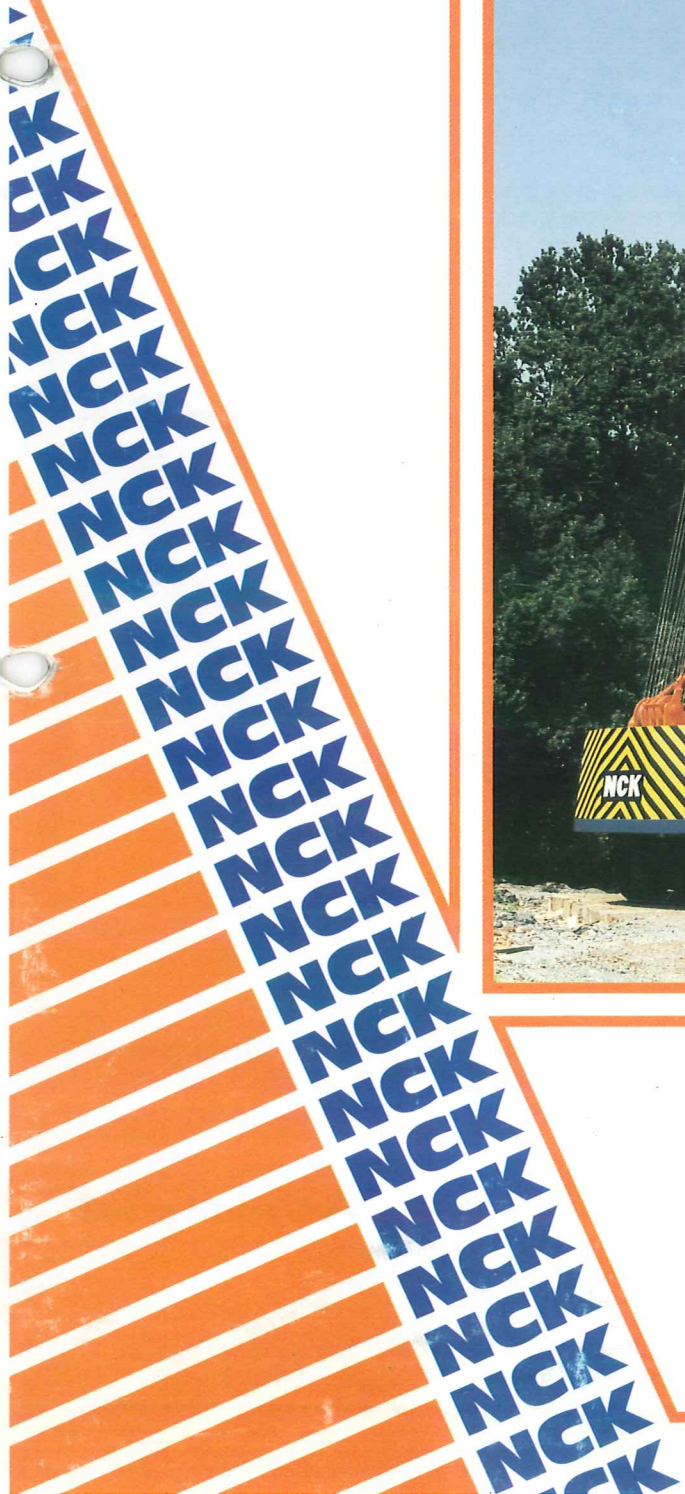

SPECIFICATION

Crawler Units

Tracks: independently driven by a bent axis piston motor through a triple reduction gearbox, incorporating a multi-disc brake. This mechanism provides for independent control to travel, steer or contra-rotation for maximum manoeuvrability.

Hydraulic system also provides braking to prevent downhill movement.

Crawler Frames: Box section all welded construction, precision machined to accept drive gearbox and lower roller system. Drive sprocket, idler wheel and lower rollers are lifetime lubricated. Tension adjustment on track belt is provided hydraulically.

To ensure transportation within European Road Regulations crawler frames are provided with hydraulic cylinders to facilitate easy retractability.

Track Shoes: Heavy duty high tensile heat treated with abrasion resistant plate.

Carbody: High strength steel fabrication incorporating box section axle extensions to accept crawler frames. Forged steel top ring machined to accept bolt-on slew ring.

Power Unit

Caterpillar Model 3306B-DITA water cooled 4-stroke, 6-cylinder direct injected turbo-charged industrial diesel engine. (see page 5 for full specification).

Turntable

Welded steel structure consisting of two rolled beams as main longitudinal members connected by transverse beams and platework for strength and rigidity.

The structure is precision machined for hoist units, swing unit and lattice boom. The superstructure revolves on a totally enclosed anti-friction slewing ring.

Main and Auxiliary Hoist Units

Main and auxiliary hoist units are driven independently by slow speed, high torque radial piston motors. Rotational direction and speed is controlled through a single lever proportional valve for precise control of hoisting/lowering.

Drums: Main and auxiliary hoist drums are fabricated from rolled steel with cast steel flanges. Rope grooves are machined for controlled rope spooling.

Both drums are mounted on high strength alloy steel shafts which revolve on anti-friction bearings.

Clutches: Drum units are connected to the drive units through large diameter internal expanding friction bands, with replaceable linings. Clutches are spring set and power released.

Brakes: External contracting friction band type, spring applied and power released. Crane (fully powered operation) brakes are automatically released when hoist/lower direction is selected and fully applied with control lever in neutral. Cyclic operation (gravity lower) brake effort is precisely controlled by servo action foot pedals and together with synchronised clutch disconnect, provide excellent control for gravity lowering.

Swing Unit

Completely independent of all other motions, swing pinion is driven by reversible high torque radial piston motor incorporating multi-disc brake. Spring applied and power released, hydraulic system provides for controlled braking.

Boom Hoist Unit

Hoist/lower unit is driven by a bent axis piston motor through a double reduction gearbox incorporating a multi-disc brake which is spring applied and power released. The brake is automatically released when main boom is hoisted or lowered and fully applied with control lever in neutral.

Hydraulic system provides for precise control of boom position. A mechanical pawl lock is provided on the boom hoist drum.

SPECIFICATION

- Operators Cab** Independent from the machinery house, cab module is mounted on a flexible sub-frame, rubber mounted windows on both sides and roof. Front and left side windows are opening. Side door gives easy access to operators position. Cab is environmentally insulated and fully equipped with instrumentation.
- Machinery House** Steel constructed, covering the engine and all operating equipment. Easy access is available for all servicing and replacement of units.
- Hydraulic System** Four hydraulic pumps driven via Splitter reduction gearbox.
- Two variable displacement piston pumps (open circuit) for operation of travel, hoist drums and boom hoist. Simultaneous control or individually.
- Single variable displacement piston pump (closed circuit) for independent control of swing motion.
- Single gear pump for control of pilot circuit or ancillary equipment.
- Main/auxiliary Motors:** dual displacement radial piston type complete with counterbalance valve.
- Boom Hoist Motor:** bent axis piston motor complete with counterbalance valve.
- Swing Motor:** high torque radial piston motor.
- Travel Motor:** bent axis piston motor.
- Hydraulic Valves:** relief valves protect all motion and control circuits from overload. Main hoist winch and boom hoist circuits incorporate counterbalance valves to ensure safe controlled lowering.
- Traction circuit also includes counterbalance valves to ensure safe travelling on inclines.
- Front End Attachment** **Tubular chord boom:** lattice construction, high tensile steel tubular chord.
Base boom: – two piece, total length 12 metres.
Lower section: – 6 metres.
Outer section: – 6 metres.
- Boom point:** – offset boom head, 5 sheaves mounted on anti-friction bearings.
- Boom inserts:** – 3m, 6m and 9m long. Pin joint connected to increase main boom length.
- Angle chord main boom is available as optional equipment.
- Fly Jib** Lattice construction, high tensile steel main chord members.
- Basic jib:** – two piece construction, total length 9 metres.
- Jib inserts:** – 3 metres long, pin joint connected.
- Jib point:** – single sheave mounted on anti-friction bearings.
- Main Boom Suspension** Pendant suspension from suspension mast which is pin connected to lower superstructure. Mast is hoisted and lowered on a 12-part rope system, located between the mast head and a fabricated frame at rear of turntable.
- All suspension sheaves are mounted on anti-friction bearings and suspension mast can be removed without unreeving the rope system.
-

SPECIFICATION

Safety Equipment

Boom overhoist: Maximum boom angle is restricted to 80° by automatic cutout, which neutralises the hoist valve and applies the brake.

Telescopic tubular backstops are also provided between main boom and superstructure.

Counterbalance valve: To ensure machine fails safe in the event of an hydraulic failure, a brake valve is incorporated into the travel, boom hoist, main and auxiliary hoist circuits. This valve is automatically activated.

Overhoist limit: When hook block reaches its set/safety limit, brakes are automatically engaged and audible alarm is activated.

Drum lock: Boom hoist drum is fitted with a safety pawl lock.

Brake system: To ensure maximum safety all brakes are fail safe type, spring applied and power released.

Safe load indicator: An electronic audible and visible automatic safe load indicator is available for main boom and fly jib operation.

Indicator records the operating radius, suspended load (actual) and the safe working load.

The load sensing unit is incorporated into the boom hoist system, making it suitable for cyclic duty and foundation applications, in addition to normal liftcrane loadings.

HC65 DATA

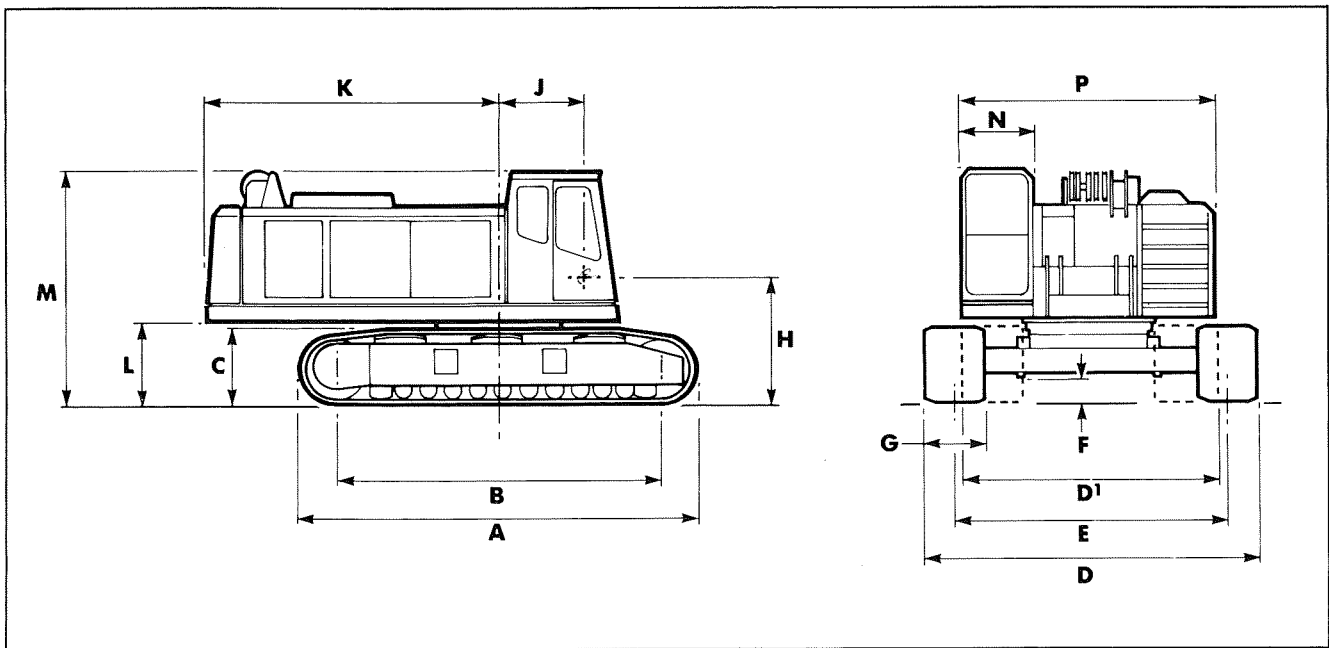

DIMENSIONS

	metres
A Overall length of crawler units	6.03
B Distance, centre to centre of tumblers	5.00
C Height of crawler units	1.13
D Overall width of crawlers: Extended – in working condition	4.60
D' Retracted – in travelling condition	3.50
E Centre to centre of crawler units in working condition	3.74
F Ground clearance	420mm
G Crawler shoe width	850mm

	metres
H Height of boom foot	1.89
J Distance centre line rotation to boom foot	1.16
K Tailradius to rear of counterweight	4.27
L Ground clearance under counterweight	1.295
M Overall height of "A" frame sheave, and operators cab in working condition	3.39
N Width of Operators Module	950mm
P Overall width over machinery cab	3.44

POWER UNIT

Manufacturer	Caterpillar
Model	3306-DIT
Type	4-cycle diesel engine
Number of cylinders	6
Bore (mm)	121

Stroke (mm)	152
Output power – B.H.P. (kW)	240 (180)
Speed (rpm)	2000
Fuel tank capacity – litres (galls)	400 (88)
Electrical system (volts)	24

WINCH DRUM DATA Rope Pulls and Speeds

LIFTCRANE

Main hoist drum P.C.D. (mm)	514
Drum length (mm)	585
Main hoist rope dia. (mm)	24
Max. rope capacity (M)	150
1st layer capacity (M)	34
Effective rope pull (kg)	15000
Max. rope pull (kg)	17740
Main/aux. rope speed (hoist/lower) (M/min)	0 – 126
Auxiliary hoist drum P.C.D. (mm)	514
Drum length (mm)	585
Aux. hoist rope dia. (mm)	24
Max. rope capacity (M)	150
1st layer capacity (M)	34







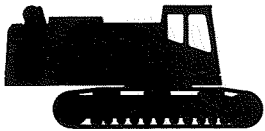

GRABCRANE

Closing/holding drum P.C.D. (mm)	590
Drum length (mm)	585
Closing/holding rope dia. (mm)	24
Max. rope capacity (M)	85
1st layer capacity (M)	39
Effective rope pull (kg)	15400
Rope speed (M/Min)	0 – 72

BOOM SUSPENSION

Type	Mast – Pendant
Boom hoist drum P.C.D. (mm)	385
Boom hoist rope dia. (mm)	16
Pendant rope dia. (mm)	26
Swing speed (rpm)	0 – 3
Travel speed (kM/hr)	0 -1.52

WEIGHTS of major components

	kg.
BASE MACHINE (without counterweight) 	43 860
UPPER UNIT (without counterweight) 	13 750
CRAWLER UNITS 	11 705
CARBODY 	6 700
BASIC BOOM (12M) 	1 840
BOOM INSERTS 	3M 272 6M 480 9M 685
FLY JIBS 	9M 610 12M 750 15M 890
COUNTERWEIGHT 	18 110

Offset Head Boom Radius Diagram

Users are referred to British Standards Code of Practice (CP 3010:1972) "Safe Use of Cranes", which gives guidance for the safe application and operation of mobile cranes.

The Gross Working Loads listed in the duty tables are to be used under the following conditions:

Warning

Operating this equipment in excess of the rated loads shown in the following capacity charts or contrary to our Instruction Manual will result in unsafe conditions, damage to the machine and invalidate the warranty.

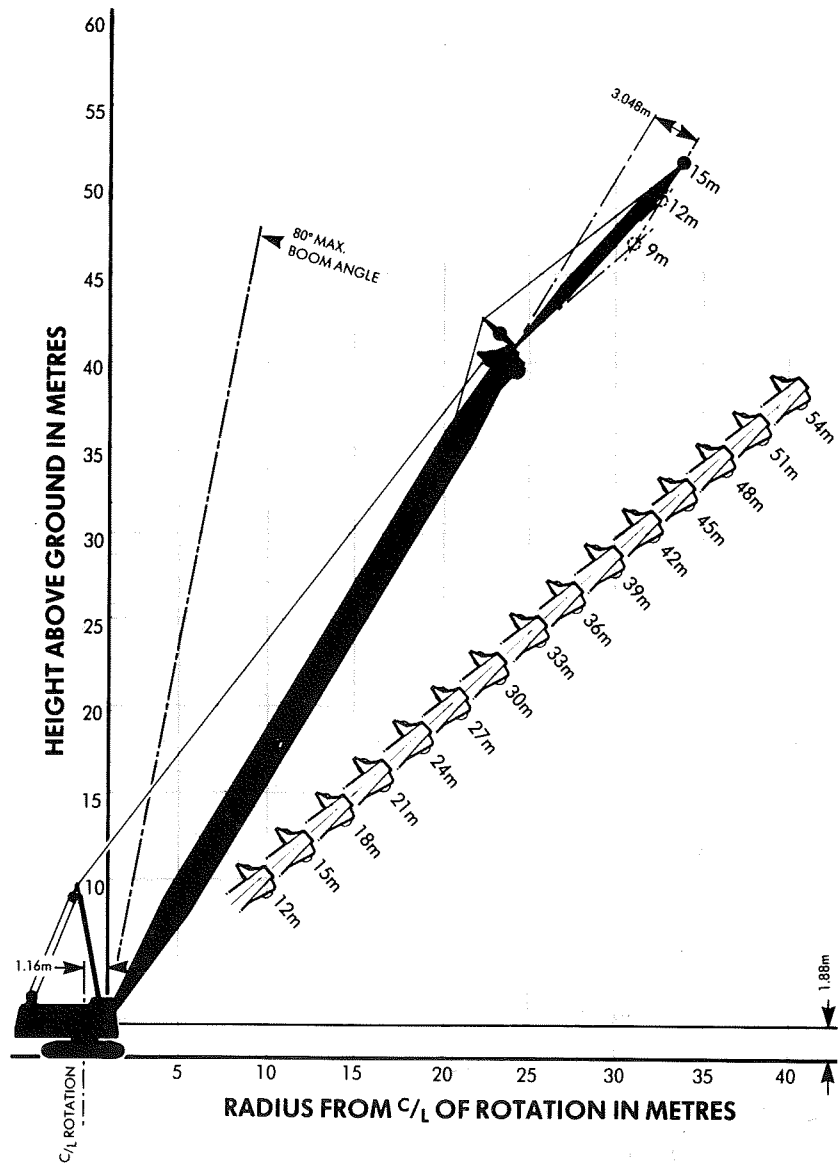

I.S.O. 4305:1981, BS 1757:1986, D.I.N. 15019 pt. 2, Crane Ratings

Capacities in accordance with the requirements of Clause 11, Stability of BS 1757:1986 with wind forces to Table 2(a) and 3(a) of BS 2573, Part 1:1977 and also meet the Determination of Stability of International Standard ISO 4305, and Stability of Mobile Cranes DIN 15019 part 2.

Loads must be freely suspended and the machine standing on firm ground, level to less than 1 in 100.

Loads shown are gross and the weights of all hook blocks, slings, etc., must be deducted to determine nett working loads.

75% Crane Ratings

Rated loads do not exceed 75% of the tipping loads but in certain instances, are further governed by structural limitations.

Ratings are based on freely suspended loads and make no allowance for such factors as wind effects, ground conditions, out of level, operating speeds or any other conditions that could be detrimental to the safe operation of this equipment.

Loads shown are gross and the weights of all hook blocks, slings, etc., must be deducted to determine nett working loads.

Main Boom Loads

Main boom with off-set head – maximum capacity 65,000 kg., maximum length 54.0m.

When a fly jib is fitted the effective weight of all hook blocks, tackle, etc., must be deducted when calculating nett working loads. The main boom loads must be further reduced by the following, to allow for the weight of the fly jib:

- 9m Fly jib – reduce by 916 kg
- 12m Fly jib – reduce by 1098 kg
- 15m Fly jib – reduce by 1270 kg

Maximum length of main boom, when fly jib is fitted – 45.0m.

Fly Jib Loads

Maximum fly jib gross loads:

- 9m Fly jib 6300 kg
- 12m Fly jib 5490 kg
- 15m Fly jib 4470 kg

Effective weight of all suspended hook blocks, slings and tackle must be deducted when calculating nett working loads.

Fly jib offset

With the standard pendant ropes supplied for each fly jib the offset of the fly jib head from the centre line of the main boom is 3.048m, regardless of fly jib length.

This offset dimension must be maintained at all times.

Liftcrane Hoist Rope Loads

24mm Rope

No. of Parts of Rope	Maximum Lifting Capacity Kg
1	9150
2	18120
3	26910
4	35540
5	44000
6	52300
7	60410
8	65000

The above capacities are derived from rope factors of safety to BS 1757:1986; also in accordance with P.C.S.A. Standard No. 1, and maximum pulls from hoist drums.

HC65 DATA

LIFTING CAPACITIES OFFSET HEAD BOOM MAIN BOOM (with maximum counterweight)

METRIC

Boom length	Radius	Boom angle	GROSS WORKING LOAD	
			BS 1757:1986	75% Rating
m	m	degrees	kg	kg
12.0	3.6	80	65000	65000
	4.0	78	65000	65000
	5.0	73	47900	45000
	6.0	68	35800	33600
	7.0	63	28400	26700
	8.0	57	23500	22100
	9.0	51	20000	18900
	10.0	44	17300	16400
15.0	4.1	80	60400	64000
	5.0	77	47900	45000
	6.0	73	35700	33600
	7.0	68	28400	26700
	8.0	64	23500	22100
	9.0	60	20000	18800
	10.0	55	17300	16300
	12.0	45	13600	12800
18.0	4.6	80	52300	52000
	5.0	79	47900	45000
	6.0	76	35700	33600
	7.0	72	28400	26700
	8.0	69	23400	22100
	9.0	65	19900	18800
	10.0	62	17200	16300
	12.0	54	13500	12800
21.0	5.2	80	44000	42000
	6.0	78	35700	33600
	7.0	75	28300	26700
	8.0	72	23400	22100
	9.0	69	19900	18700
	10.0	66	17200	16200
	12.0	60	13500	12700
	14.0	53	11000	10400
24.0	5.7	80	38600	36400
	6.0	79	35700	33600
	7.0	77	28300	26700
	8.0	74	23400	22000
	9.0	72	19800	18700
	10.0	69	17100	16200
	12.0	64	13400	12700
	14.0	59	10900	10300
27.0	6.2	80	33800	31800
	7.0	78	28200	26600
	8.0	76	23300	22000
	9.0	74	19700	18600
	10.0	72	17100	16100
	12.0	67	13300	12600
	14.0	62	10800	10300
	16.0	57	9000	8600
18.0	52	7700	7300	
20.0	46	6600	6300	
22.0	40	5800	5600	
24.0	33	5100	4900	

Boom length	Radius	Boom angle	GROSS WORKING LOAD	
			BS 1757:1986	75% Rating
m	m	degrees	kg	kg
30.0	6.7	80	30100	28300
	7.0	79	28200	26600
	8.0	78	23200	21900
	9.0	76	19700	18600
	10.0	74	17000	16100
	12.0	70	13300	12600
	14.0	65	10800	10200
	16.0	61	9000	8500
	18.0	57	7600	7300
	20.0	52	6600	6300
	22.0	47	5700	5500
	24.0	41	5000	4900
	26.0	35	4500	4300
	28.0	27	4000	3900
33.0	7.2	80	26500	25400
	8.0	79	23100	21800
	9.0	77	19600	18500
	10.0	75	16900	16000
	12.0	71	13200	12500
	14.0	68	10700	10100
	16.0	64	8900	8500
	18.0	60	7500	7200
	20.0	56	6500	6200
	22.0	51	5600	5400
	24.0	47	4900	4800
	26.0	42	4400	4200
	28.0	36	3900	3800
	30.0	30	3500	3400
36.0	8.0	80	22800	21800
	9.0	78	19500	18400
	10.0	76	16800	15900
	12.0	73	13100	12400
	14.0	70	10600	10100
	16.0	66	8800	8400
	18.0	63	7400	7100
	20.0	59	6400	6100
	22.0	55	5500	5300
	24.0	51	4800	4700
	26.0	47	4300	4200
	28.0	42	3800	3700
	30.0	37	3400	3300
	32.0	32	3000	3000
39.0	8.3	80	19800	20600
	9.0	79	19400	18400
	10.0	77	16700	15900
	12.0	74	13000	12300
	14.0	71	10500	10000
	16.0	68	8700	8300
	18.0	65	7300	7000
	20.0	62	6300	6000
	22.0	58	5400	5300
	24.0	55	4700	4600
	26.0	51	4200	4100
	28.0	47	3700	3600
	30.0	43	3300	3200
	32.0	38	2900	2900
34.0	33	2600	2600	
36.0	27	2400	2400	

HC65 DATA

LIFTING CAPACITIES OFFSET HEAD BOOM MAIN BOOM (with maximum counterweight)

METRIC

Boom length	Radius	Boom angle	GROSS WORKING LOAD	
			BS 1757:1986	75% Rating
m	m	degrees	kg	kg
42.0	8.8	80	16700	18900
	9.0	80	16400	18300
	10.0	78	16300	15800
	12.0	76	12900	12300
	14.0	73	10400	10000
	16.0	70	8600	8300
	18.0	67	7300	7000
	20.0	64	6200	6000
	22.0	61	5400	5200
	24.0	58	4700	4600
	26.0	54	4100	4000
	28.0	51	3600	3600
	30.0	47	3200	3200
	32.0	43	2900	2900
	34.0	39	2500	2600
	36.0	34	2300	2300
	38.0	29	2000	2100
40.0	23	1800	1900	
45.0	9.3	80	14500	17400
	10.0	79	14300	15800
	12.0	77	12800	12200
	14.0	74	10300	9900
	16.0	71	8500	8200
	18.0	68	7200	6900
	20.0	66	6100	5900
	22.0	63	5300	5100
	24.0	60	4600	4500
	26.0	57	4000	4000
	28.0	54	3500	3500
	30.0	51	3100	3100
	32.0	47	2800	2800
	34.0	44	2400	2500
	36.0	40	2200	2200
38.0	35	1900	2000	
40.0	31	1700	1800	
48.0	10.0	80	12600	15700
	12.0	77	12100	12100
	14.0	75	10200	9800
	16.0	72	8400	8100
	18.0	70	7100	6800
	20.0	67	6000	5800
	22.0	65	5200	5000
	24.0	62	4500	4400
	26.0	59	3900	3900
	28.0	56	3400	3400
	30.0	53	3000	3000
	32.0	50	2600	2700
	34.0	47	2300	2400
36.0	44	2000	2100	
38.0	40	1800	1900	
40.0	36	1600	1700	

Boom length	Radius	Boom angle	GROSS WORKING LOAD	
			BS 1757:1986	75% Rating
m	m	degrees	kg	kg
51.0	10.4	80	11100	14700
	12.0	78	10700	12000
	14.0	76	10100	9700
	16.0	73	8300	8000
	18.0	71	7000	6700
	20.0	69	5900	5700
	22.0	66	5100	5000
	24.0	64	4400	4300
	26.0	61	3800	3800
	28.0	59	3300	3300
	30.0	56	2900	2900
	32.0	53	2500	2600
	34.0	50	2200	2300
	36.0	47	1900	2000
	38.0	44	1700	1800
	40.0	41	1500	1600
	54.0	11.0	80	9700
12.0		79	9500	12000
14.0		77	9000	9600
16.0		74	8200	7900
18.0		72	6900	6600
20.0		70	5800	5600
22.0		68	5000	4900
24.0		65	4300	4200
26.0		63	3700	3700
28.0		61	3200	3200
30.0		58	2800	2800
32.0		56	2400	2500
34.0		53	2100	2200
36.0	50	1800	1900	
38.0	47	1600	1700	
40.0	44	1400	1500	

HC65 DATA

FLY JIB DUTIES

BS 1757:1986
75%

		Main Boom Lengths 9M FLY JIB								
Rating	Radius m	21M	24M	27M	30M	33M	36M	39M	42M	45M
		kg	kg	kg	kg	kg	kg	kg	kg	kg
BS 1757 75%	9.6	6300 6300								
BS 1757 75%	10.0	6300 6300								
BS 1757 75%	10.1		6300 6300							
BS 1757 75%	10.6			6300 6300						
BS 1757 75%	11.0	6300 6300	6300 6300	6300 6300						
BS 1757 75%	11.1				6300 6300					
BS 1757 75%	11.6					6300 6300				
BS 1757 75%	12.0	6300 6300	6300 6300	6300 6300	6300 6300	6300 6300				
BS 1757 75%	12.1						6300 6300			
BS 1757 75%	12.7							6300 6300		
BS 1757 75%	13.0	6240 6240	6300 6300	6300 6300	6300 6300	6300 6300	6300 6300			
BS 1757 75%	13.2								6300 6300	
BS 1757 75%	13.7									6300 6300
BS 1757 75%	14.0	6140 6140	6230 6230	6300 6300	6300 6300	6300 6300	6300 6300	6300 6300	6300 6300	6300 6300
BS 1757 75%	15.0	6050 6050	6140 6140	6220 6220	6300 6300	6300 6300	6300 6300	6300 6300	6300 6300	6300 6300
BS 1757 75%	16.0	5990 5990	6060 6060	6130 6130	6210 6210	6280 6280	6300 6300	6300 6300	6300 6300	6300 6300
BS 1757 75%	18.0	5540 5540	5940 5940	6010 6010	6070 6070	6130 6130	6200 6200	6260 6260	6300 6300	6300 6300
BS 1757 75%	20.0	5040 5040	5360 5360	5670 5670	5960 5960	6020 6020	6070 6070	6130 6130	6190 6190	6240 6240
BS 1757 75%	22.0		4940 4940	5230 5230	5500 5500	5770 5770	5990 5990	5850 5680	5750 5600	5650 5510
BS 1757 75%	24.0		4580 4580	4850 4850	5110 5110	5280 5130	5180 5040	5080 4960	4990 4880	4880 4800
BS 1757 75%	26.0			4530 4530	4750 4620	4640 4530	4540 4450	4440 4370	4350 4280	4240 4200
BS 1757 75%	28.0				4210 4120	4100 4030	4000 3940	3900 3860	3800 3780	3700 3690
BS 1757 75%	30.0					3640 3590	3540 3510	3440 3430	3340 3340	3230 3250
BS 1757 75%	32.0						3130 3130	3040 3050	2930 2960	2830 2880
BS 1757 75%	34.0						2780 2800	2680 2720	2580 2630	2470 2540
BS 1757 75%	36.0							2370 2430	2270 2340	2160 2250
BS 1757 75%	38.0								1990 2080	1880 1990
BS 1757 75%	40.0								1740 1850	1630 1760

VALUES BELOW BLACK LINE ARE STABILITY VALUES

HC65 DATA

FLY JIB DUTIES

BS 1757:1986
75%

Main Boom Lengths 12M FLY JIB

Rating	Radius m	21M	24M	27M	30M	33M	36M	39M	42M	45M
		kg	kg	kg	kg	kg	kg	kg	kg	kg
BS 1757 75%	10.1	5490 5490								
BS 1757 75%	10.7		5490 5490							
BS 1757 75%	11.0	5350 5350	5440 5440							
BS 1757 75%	11.2			5490 5490						
BS 1757 75%	11.7				5490 5490					
BS 1757 75%	12.0	5200 5200	5300 5300	5380 5380	5450 5450					
BS 1757 75%	12.2					5490 5490				
BS 1757 75%	12.8						5490 5490			
BS 1757 75%	13.0	5050 5050	5160 5160	5250 5250	5330 5330	5400 5400	5460 5460			
BS 1757 75%	13.3							5490 5490		
BS 1757 75%	13.8								5490 5490	
BS 1757 75%	14.0	4900 4900	5020 5020	5130 5130	5210 5210	5290 5290	5360 5360	5410 5410	5460 5460	
BS 1757 75%	14.3									5490 5490
BS 1757 75%	15.0	4740 4740	4880 4880	5000 5000	5100 5100	5180 5180	5250 5250	5320 5320	5370 5370	5420 5420
BS 1757 75%	16.0	4650 4650	4740 4740	4870 4870	4980 4980	5070 5070	5150 5150	5220 5220	5280 5280	5340 5340
BS 1757 75%	18.0	4520 4520	4610 4610	4650 4650	4740 4740	4850 4850	4940 4940	5030 5030	5100 5100	5170 5170
BS 1757 75%	20.0	4040 4040	4320 4320	4580 4580	4620 4620	4650 4650	4730 4730	4830 4830	4920 4920	5000 5000
BS 1757 75%	22.0		3910 3910	4160 4160	4390 4390	4600 4600	4630 4630	4660 4660	4730 4730	4820 4820
BS 1757 75%	24.0		3600 3600	3800 3800	4020 4020	4240 4240	4450 4450	4610 4610	4630 4630	4660 4660
BS 1757 75%	26.0			3500 3500	3710 3710	3910 3910	4110 4110	4300 4300	4350 4290	4250 4200
BS 1757 75%	28.0				3430 3430	3630 3630	3820 3820	3920 3870	3810 3790	3710 3700
BS 1757 75%	30.0				3200 3200	3380 3380	3550 3520	3450 3440	3350 3350	3240 3260
BS 1757 75%	32.0						3150 3150	3050 3060	2950 2980	2840 2890
BS 1757 75%	34.0						2800 2820	2700 2730	2590 2650	2490 2560
BS 1757 75%	36.0							2390 2440	2280 2360	2170 2260
BS 1757 75%	38.0								2000 2100	1900 2000
BS 1757 75%	40.0								1760 1860	1650 1770

VALUES BELOW BLACK LINE ARE STABILITY VALUES

HC65 DATA

FLY JIB DUTIES

BS 1757:1986

75%

Main Boom Lengths 15M FLY JIB

Rating	Radius m	21M	24M	27M	30M	33M	36M	39M	42M	45M
		kg	kg	kg	kg	kg	kg	kg	kg	kg
BS 1757 75%	10.7	4470 4470								
BS 1757 75%	11.0	4430 4430								
BS 1757 75%	11.2		4470 4470							
BS 1757 75%	11.7			4470 4470						
BS 1757 75%	12.0	4340 4340	4400 4400	4440 4400						
BS 1757 75%	12.2				4470 4470					
BS 1757 75%	12.8					4470 4470				
BS 1757 75%	13.0	4240 4240	4310 4310	4360 4360	4410 4410	4450 4450				
BS 1757 75%	13.3						4470 4470			
BS 1757 75%	13.8							4470 4470		
BS 1757 75%	14.0	4150 4150	4220 4220	4280 4280	4330 4330	4380 4380	4420 4420	4450 4450		
BS 1757 75%	14.3								4470 4470	
BS 1757 75%	14.8									4470 4470
BS 1757 75%	15.0	4050 4050	4130 4130	4200 4200	4260 4260	4310 4310	4350 4350	4390 4390	4430 4430	4460 4460
BS 1757 75%	16.0	3950 3950	4040 4040	4110 4110	4180 4180	4240 4240	4280 4280	4330 4330	4370 4370	4400 4400
BS 1757 75%	18.0	3780 3780	3870 3870	3950 3950	4020 4020	4090 4090	4150 4150	4200 4200	4250 4250	4290 4290
BS 1757 75%	20.0	3430 3430	3660 3660	3800 3800	3870 3870	3940 3940	4010 4010	4070 4070	4130 4130	4170 4170
BS 1757 75%	22.0		3270 3270	3480 3480	3680 3680	3820 3820	3880 3880	3940 3940	4000 4000	4060 4060
BS 1757 75%	24.0		2940 2940	3140 3140	3330 3330	3520 3520	3700 3700	3830 3830	3880 3880	3940 3940
BS 1757 75%	26.0		2670 2670	2850 2850	3030 3030	3210 3210	3380 3380	3540 3540	3710 3710	3840 3840
BS 1757 75%	28.0			2610 2610	2780 2780	2940 2710	3100 3100	3260 3260	3420 3420	3570 3570
BS 1757 75%	30.0						2860 2860	3010 3010	3160 3160	3220 3240
BS 1757 75%	32.0						2650 2650	2790 2790	2930 2930	2820 2870
BS 1757 75%	34.0						2460 2460	2600 2600	2570 2630	2460 2540
BS 1757 75%	36.0							2370 2430	2260 2340	2150 2250
BS 1757 75%	38.0								1990 2080	1880 1990
BS 1757 75%	40.0								1740 1850	1630 1760

VALUES BELOW BLACK LINE ARE STABILITY VALUES

The information contained in this publication is of a general nature only. We reserve the right to make alterations and additions without notice.

NCK CRANES Ltd.

Manufacturers of Crawler Cranes and Contractors Plant

Olympus Close,
Whitehouse Industrial Estate,
Ipswich, Suffolk IP1 5LN

Tel: (01473) 240111
Fax: (01473) 462120